

D9-EB-4

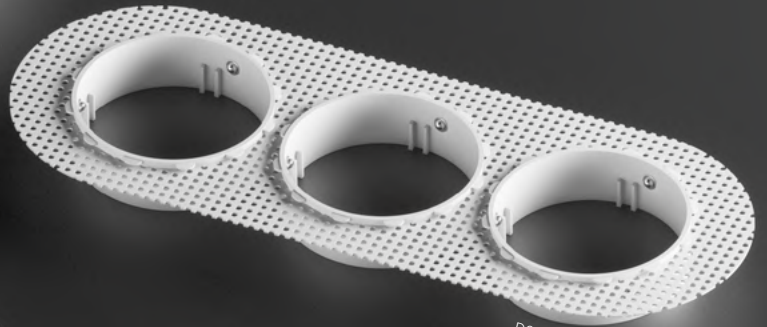

D9-EB-3

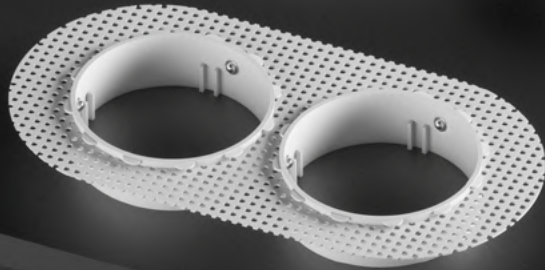

D9-EB-2

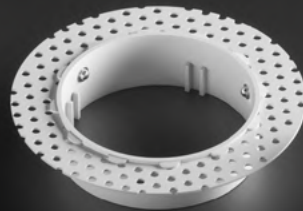

D9-EB-1

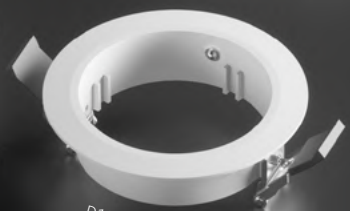

D10 frame



D9-1-A



D9-2-A



D9-1



D9-2

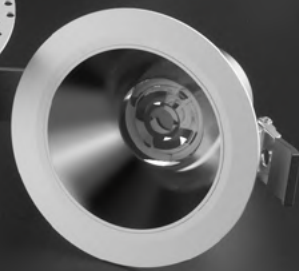
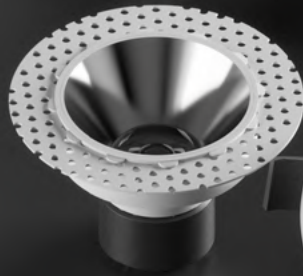
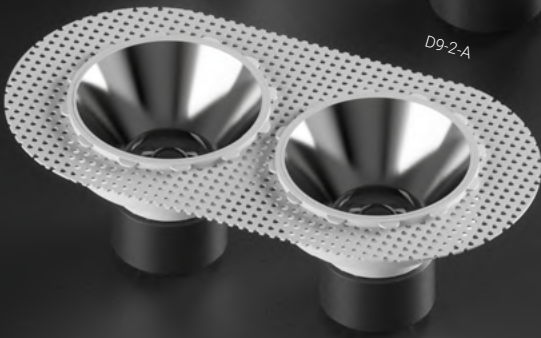

D10

Bloc



Retrofit concept, change modules without taking out the whole fixture.

快速更換模組，實現 DIY 目標

Embedded frame 預埋框

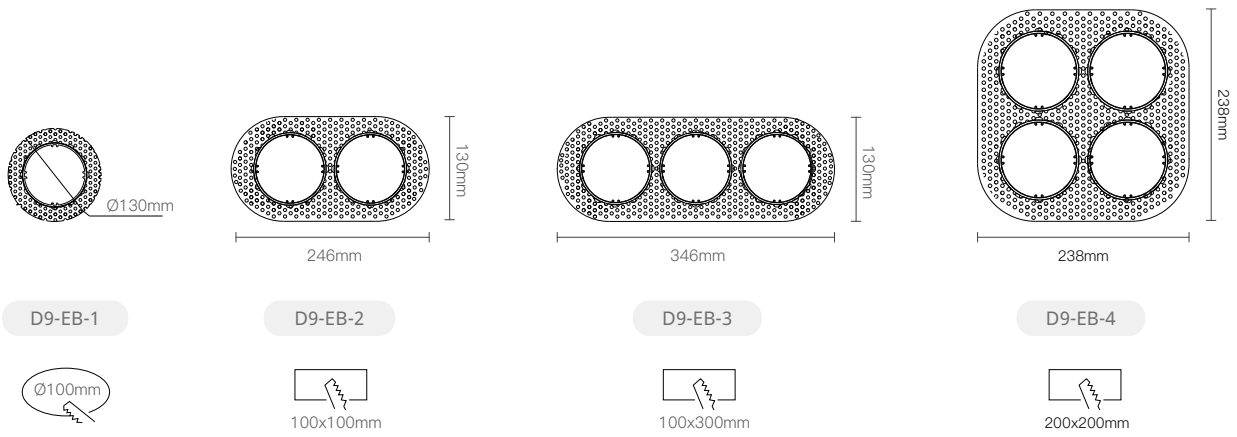

Installation steps 安裝方式



D9-1
Bloc Series



- 黑色/Black
- 灰色/Grey
- 白色/White

線圖/Dimensions

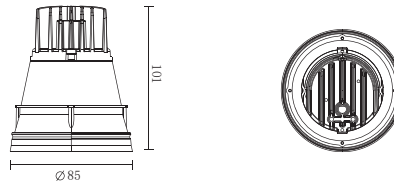

調光控制系統/Dimming Control



規格/Technical Specifications

輸入電壓:100-240V 50/60Hz
 功率:8W
 光通量:800lm
 材質:鋁
 光束角:15°/20°/30°
 顯示指數:≥90
 色溫:2700K/3000K/4000K/雙色溫
 Input Voltage:100-240V 50/60Hz
 Power:8W
 Luminous Flux:800lm
 Material:Aluminum
 BA.:15°/20°/30°
 CRI:≥90
 CCT:2700K/3000K/4000K/Tunable

配光曲線圖/Light pattern

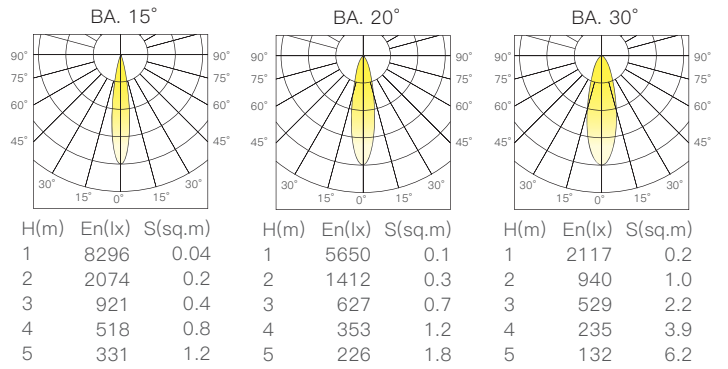

D9-1-A

Bloc Series



- 黑色/Black
- 灰色/Grey
- 白色/White

線圖/Dimensions

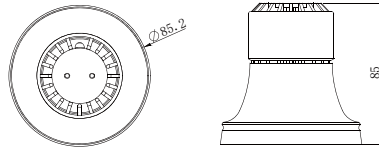

調光控制系統/Dimming Control



定電流
non-dim



可控矽
Triac



0-10V



DALI



Aco Smart

規格/Technical Specifications

輸入電壓:100-240V 50/60Hz
 功率:12W
 光通量:1000lm
 材質:鋁
 光束角:15°/24°/30°
 顯示指數:≥90
 色溫:2700K/3000K/4000K/雙色溫
 Input Voltage:100-240V 50/60Hz
 Power:12W
 Luminous Flux:1000lm
 Material:Aluminum
 BA.:15°/24°/30°
 CRI:≥90
 CCT:2700K/3000K/4000K/Tunable

配光曲線圖/Light pattern

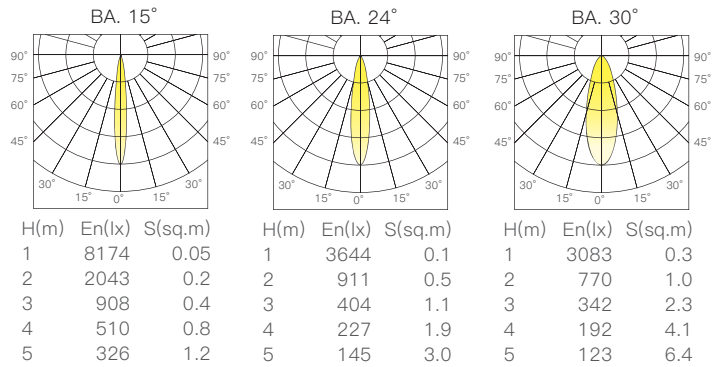

D9-2 Bloc Series



- 黑色/Black
- 灰色/Grey
- 白色/White

線圖/Dimensions

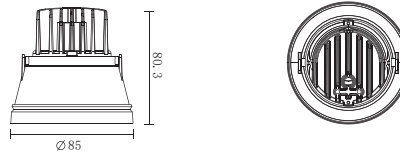

調光控制系統/Dimming Control



規格/Technical Specifications

輸入電壓:100-240V 50/60Hz
 功率:8W
 光通量:800lm
 材質:鋁
 光束角:24°/45°
 顯示指數:≥90
 色溫:2700K/3000K/4000K/雙色溫
 Input Voltage:100-240V 50/60Hz
 Power:8W
 Luminous Flux:800lm
 Material:Aluminum
 BA.:24°/45°
 CRI:≥90
 CCT:2700K/3000K/4000K/Tunable

配光曲線圖/Light pattern

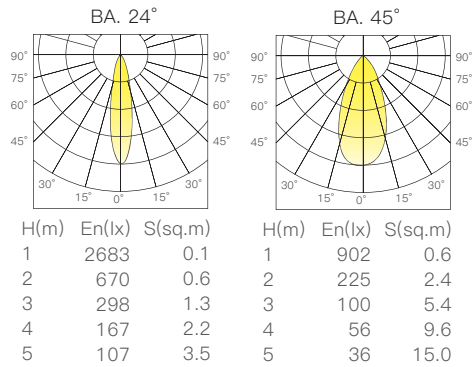

D9-2-A

Bloc Series



- 黑色/Black
- 灰色/Grey
- 白色/White

線圖/Dimensions

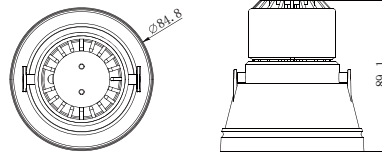

調光控制系統/Dimming Control



定電流
non-dim



可控硅
Triac



0-10V



DALI



Aco Smart

規格/Technical Specifications

輸入電壓:100-240V 50/60Hz
 功率:12W
 光通量:1000lm
 材質:鋁
 光束角:15°/24°/30°
 顯示指數:≥90
 色溫:2700K/3000K/4000K/雙色溫
 Input Voltage:100-240V 50/60Hz
 Power:12W
 Luminous Flux:1000lm
 Material:Aluminum
 BA.:15°/24°/30°
 CRI:≥90
 CCT:2700K/3000K/4000K/Tunable

配光曲線圖/Light pattern

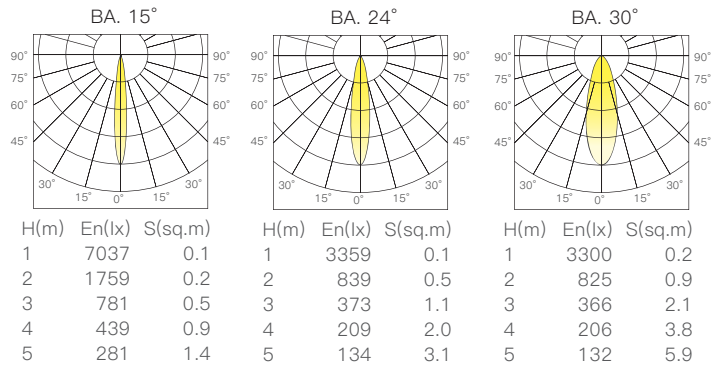

D9-5
Bloc Series



- 黑色/Black
- 灰色/Grey
- 白色/White

線圖/Dimensions

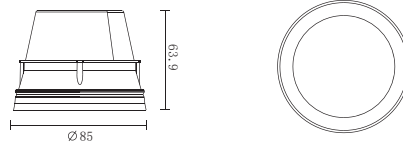

調光控制系統/Dimming Control



定電流
non-dim



可控矽
Triac



0-10V



DALI



Aco Smart

規格/Technical Specifications

輸入電壓:100-240V 50/60Hz
 功率:8W
 光通量:300lm
 材質:鋁
 光束角:85°
 顯示指數:≥90
 色溫:2700K/3000K/4000K/5700K
 Input Voltage:100-240V 50/60Hz
 Power:8W
 Luminous Flux:300lm
 Material:Aluminum
 BA.:85°
 CRI:≥90
 CCT:2700K/3000K/4000K/5700K

配光曲線圖/Light pattern

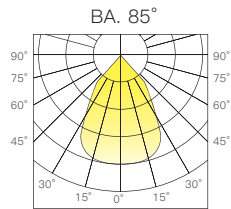

H(m)	En(lx)	S(sq.m)
1	178	2.6
2	44	10.5
3	19	23.7
4	11	42.0
5	7	65.7



D10-1

Bloc Series



- 黑色/Black
- 灰色/Grey
- 白色/White

線圖/Dimensions

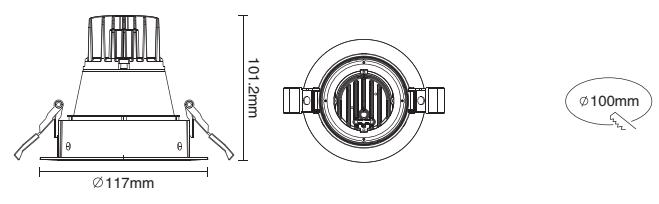

調光控制系統/Dimming Control

定電流 non-dim
 可控矽 Triac
 0-10V
 DALI
 Aco Smart

規格/Technical Specifications

輸入電壓:100-240V 50/60Hz
 功率:8W
 光通量:800lm
 材質:鋁
 光束角:15°/20°/30°
 顯示指數:≥90
 色溫:2700K/3000K/4000K/雙色溫
 Input Voltage:100-240V 50/60Hz
 Power:8W
 Luminous Flux:800lm
 Material:Aluminum
 BA.:15°/20°/30°
 CRI:≥90
 CCT:2700K/3000K/4000K/Tunable

配光曲線圖/Light pattern

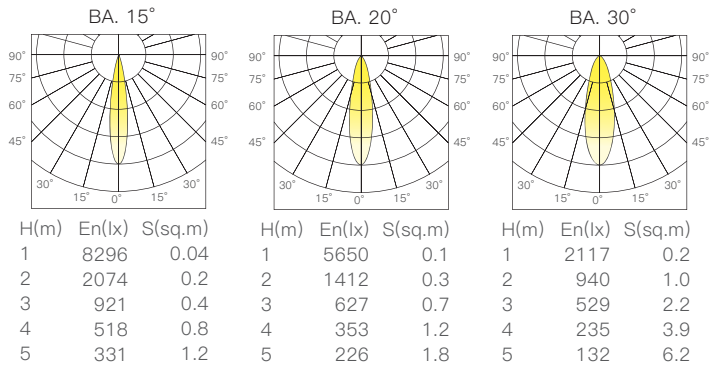

D10-2

Bloc Series



- 黑色/Black
- 灰色/Grey
- 白色/White

線圖/Dimensions

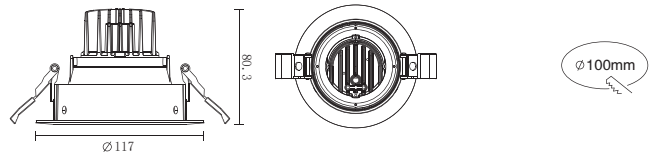

調光控制系統/Dimming Control



規格/Technical Specifications

輸入電壓:100-240V 50/60Hz
 功率:8W
 光通量:800lm
 材質:鋁
 光束角:24°/45°
 顯示指數:≥90
 色溫:2700K/3000K/4000K/雙色溫
 Input Voltage:100-240V 50/60Hz
 Power:8W
 Luminous Flux:800lm
 Material:Aluminum
 BA.:24°/45°
 CRI:≥90
 CCT:2700K/3000K/4000K/Tunable

配光曲線圖/Light pattern

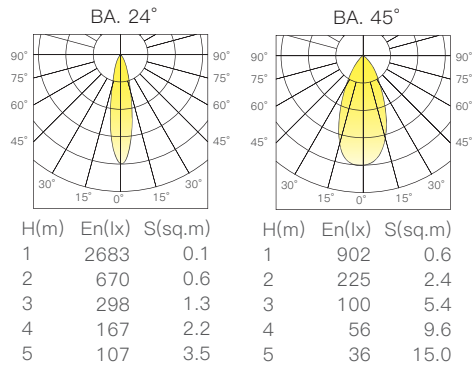

D10-3

Bloc Series



- 黑色/Black
- 灰色/Grey
- 白色/White

線圖/Dimensions

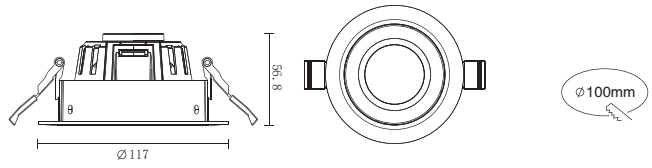

調光控制系統/Dimming Control



規格/Technical Specifications

輸入電壓:100-240V 50/60Hz
 功率:9W
 光通量:740lm
 材質:鋁
 光束角:15°/24°/36°
 顯示指數:≥90
 色溫:2700K/3000K/4000K/雙色溫
 Input Voltage:100-240V 50/60Hz
 Power:9W
 Luminous Flux:740lm
 Material:Aluminum
 BA.:15°/24°/36°
 CRI:≥90
 CCT:2700K/3000K/4000K/Tunable

配光曲線圖/Light pattern

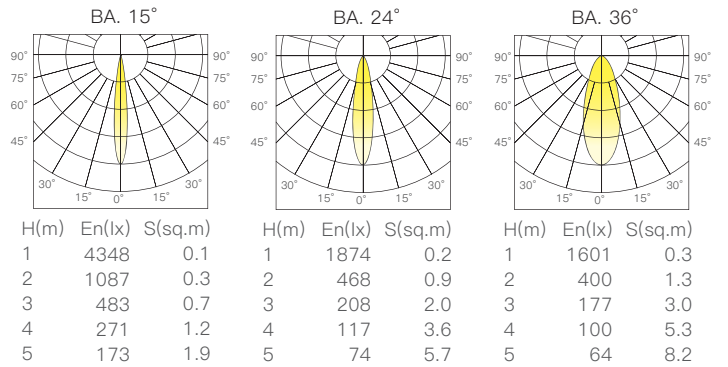

D10-5

Bloc Series



- 黑色/Black
- 灰色/Grey
- 白色/White

線圖/Dimensions

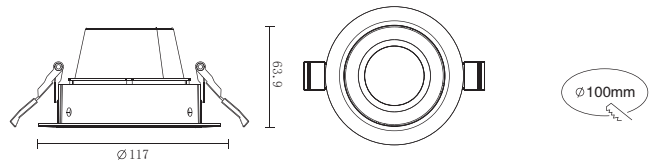

調光控制系統/Dimming Control



定電流
non-dim



可控矽
Triac



0-10V



DALI



Aco Smart

規格/Technical Specifications

輸入電壓:100-240V 50/60Hz

功率:8W

光通量:300lm

材質:鋁

光束角:85°

顯示指數:≥90

色溫:2700K/3000K/4000K/5700K

Input Voltage:100-240V 50/60Hz

Power:8W

Luminous Flux:300lm

Material:Aluminum

BA.:85°

CRI:≥90

CCT:2700K/3000K/4000K/5700K

配光曲線圖/Light pattern

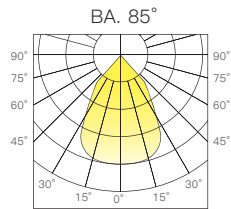

H(m)	En(lx)	S(sq.m)
1	178	2.6
2	44	10.5
3	19	23.7
4	11	42.0
5	7	65.7



D12
Bloc Series



- 黑色/Black
- 灰色/Grey
- 白色/White

線圖/Dimensions

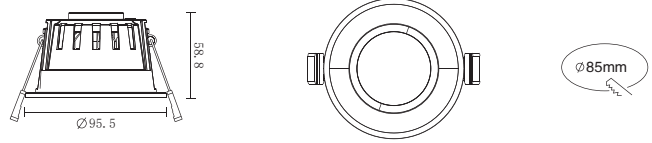

調光控制系統/Dimming Control



規格/Technical Specifications

輸入電壓:100-240V 50/60Hz
 功率:8W
 光通量:640lm
 材質:鋁
 光束角:15°/24°/36°
 顯示指數:≥90
 色溫:2700K/3000K/4000K/雙色溫
 Input Voltage:100-240V 50/60Hz
 Power:8W
 Luminous Flux:640lm
 Material:Aluminum
 BA.:15°/24°/36°
 CRI:≥90
 CCT:2700K/3000K/4000K/Tunable

配光曲線圖/Light pattern

